

QUICK START GUIDE

Maisi Camcorder M20

PRIOR TO USE

- * Install the device near the rear-view mirror to obtain the best open-field view. Do NOT install the camcorder in a location that will obstruct your required driving view.
- * Make sure that the lens is within the wiping range of the windscreen wiper to ensure a clear view even when it rains.
- * Do not touch the lens with your fingers. Finger grease may be left on the lens and will result in unclear videos or snapshots. Clean the lens on a regular basis.
- * Do not install the device on a tinted window. Doing so may damage the tint film.
- * Make sure that the installation position is not hindered by the tinted window.

CAUTION

- * Use the authorized car charger only.
- * Never disassemble or attempt to repair of this product. Doing so may damage the camcorder, cause electric shock and void your product warranty.
- * Never short-circuit the battery.
- * Set up time and date accurately before you use this camcorder.
- * Exposing the camcorder to open flames can cause explosion.
- * Due to local laws and vehicles safety considerations, do not manually operate the camcorder while driving.
- * The supplier is NOT responsible for the loss of any data/content during operation.
- * Strictly observe relevant laws as this product cannot be used for any illegal purpose. The user is responsible for any legal matters.

Before you start using the Car Camcorder it is assumed that you agree to the above statements.

How to contact us?

If you come across any issue, please feel free to drop us a quick email at: maxtopuk@gmail.com. We answer most emails within 12-24 hours. If you purchase from Amazon, you can contact us via Amazon Message as well.

1 Introduction

Thank you for purchasing this MAISI camcorder. This camcorder is specifically designed for real time video and audio recording when driving.

1.1 Features

- * High Dynamic Range Imaging (HDR)
- * HD Image 2304*1296
- * Up to 170 Degree Wide Angle Glass Lens & IR-Filter
- * Built-in G-sensor
- * Collision Detection
- * Emergency Recording File
- * GPS (GPS dongle included)

1.2 Package Contents

The package contains the following items. In case there is any missing or damaged item, contact us immediately.

- * *1x Camcorder*
- * *1x GPS Dongle*
- * *1x Mounting Bracket*
- * *2x Red 3M Pad*
- * *1x Power Charger (4M)*
- * *1x USB Cable*
- * *1x Quick Start Guide*

1.3 Product Overview

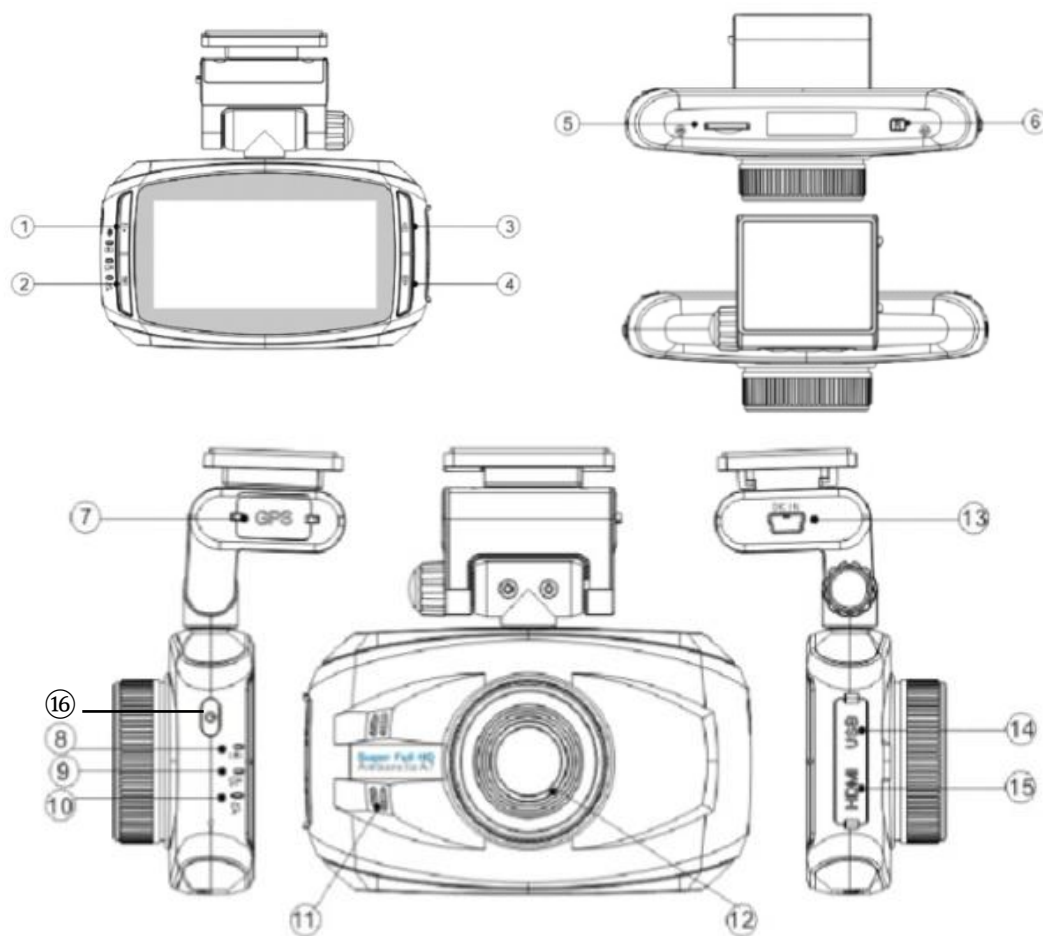

Button Illustration

Number	Button Name	Button Illustration
①	OK/MIC button	1. Long press to enable/disable Microphone while recording 2. Press to stop/start recording; take a picture; start/stop playback
②	Menu button	Press to bring up the Record/Picture/Preview/System menu;
③	Up/EV button	1.Press to go upward in the menu; 2. Press to adjust EV value while recording.
④	Down/Mode button	1.Press to go downward in the menu; 2.Press to switch among Record/Picture/ Preview Mode
⑤	Micro SD Card Slot	Insert the SD card with the gold plate facing the back of the camera; Press to eject the SD card
⑥	Reset	Press to reset the camcorder in abnormal situations.
⑦	GPS Port	To insert the GPS dongle
⑧	Charging Indicator	When the battery is charging, this indicator will show red light.

⑨	Recording Indicator	When the camcorder is recording, this indicator will blink blue light.
⑩	GPS Indicator	When the GPS dongle is inserted, this indicator will show constant green light.
⑪	Microphone	Enable to record audio
⑫	Lens	Fixed camera lens
⑬	DC IN Port	For power supply
⑭	USB Port	For data transmission
⑮	HDMI Port	For HDMI connection to TV etc.
⑯	Power button	1. To turn on/off the device 2. Short press to go to screensaver mode when the camcorder is recording (the screen goes black while recording continues)

Note:

* **Power Button:** Press it once to turn on the camera, long press (2-3s) to turn off the camera. Press it once when recording to turn the camera into screen saver mode.

* To go to Menu, make sure the camera is not recording. If the camera is recording, press **OK** button to stop the recording first, then press **Menu** button to go to Menu.

* Same rules apply (stop recording first) if you want to change the camera from Recording Mode to Picture Mode or Playback Mode.

1.4 Screen Interface Illustration

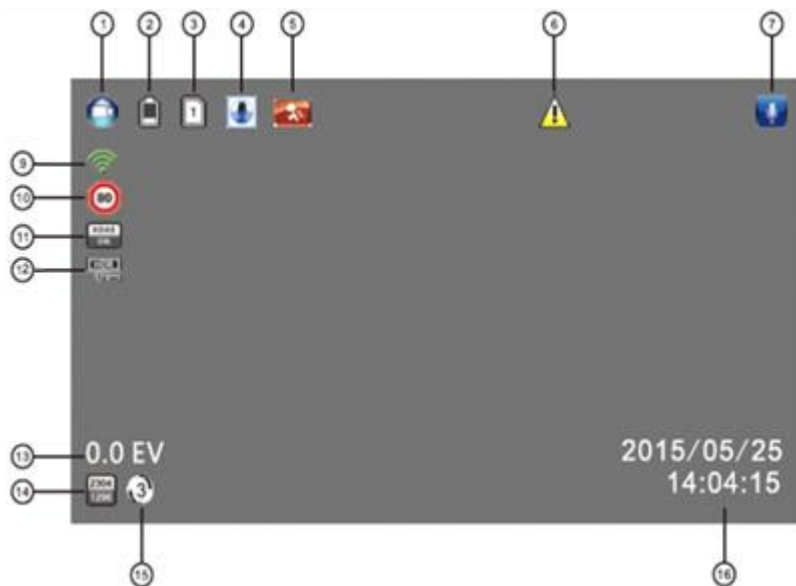

Number	Icon Name	Icon Illustration
①	Movie Camera Icon	Indicating the camcorder is in Recording Mode
②	Battery	Indicating the remaining power for the device. The average life of the battery is about 30min. Please charge your camcorder when the power is low.
③	Micro SD Card	When the card is properly inserted and recognized

		by the camcorder, this icon will show up. Otherwise it will be a "X".
④	G-Sensor	Indicating the sensitivity of the G-sensor you set. The higher the blue color stands, the more sensitive it is.
⑤	Motion Detection	This icon shows up only when motion detection is enabled. Please disable it while driving.
⑥	Emergency Recording	This Icon shows up when collision/vibration occurs and followed by device mandatory file protection. You can enable the emergency recording by pressing the Menu button while recording.
⑦	Microphone	It only shows up in Recording Mode. Long press the OK button to turn it On/Off.
⑨	GPS	When the GPS model is not inserted, this icon is red; When the GPS model inserted and is duly recognized by the camcorder, this icon will turn green and the camcorder will record route of your journey as well as the speed with the footage. If the Date/Time stamp is enabled, you will see the speed displayed on the right bottom corner of the screen.
⑩	Speed Limit	Please set the Speed Warning Setting
⑪	ADAS	Only appears when it is enabled (GPS Dongle required for Lane Departure Warning function)
⑫	HDR	When resolution is set to HDR _1920x1080@30P, it appears. HDR function can achieve more clear images in dark/dim environment.
⑬	EV	Exposure Value, "+" means brighter, "-" means dimmer
⑭	Video Resolution	The video resolution you set.
⑮	Loop Recording	The loop setting time you chosen will be displayed in the middle of this icon. For the current setting, the loop time is 3 Minutes.
⑯	Date/Time Stamp	If enabled, the model number/speed/car plate number/date/ time will be displayed on the right bottom corner on the screen, and this info will be saved on the recording. Only when the GPS model is inserted and recognized will the speed info be shown.

2 Getting Started

2.1 Inserting the Memory Card

Insert the memory card with the gold contacts facing the back of the camcorder. Push the memory card until it clicks into place.

To remove the memory card

Push to eject the memory card out of the slot.

Note:

1. Do not remove or insert the memory card when the camcorder is turned on. This may damage the memory card.
2. It is recommended to use a 32GB, Class 10 or above micro SD card.
3. **Please format the micro SD card prior to the initial use.**
4. If the screen shows "Low Speed Card" while recording, it means the writing speed of the memory card is too slow. Please replace it with a higher-speed memory card.

2.2 Installing in Vehicles

2.2.1 Mount to windshield

1. Attach the bracket to the camcorder. Slide it into the bracket holder.
2. Before installing the bracket, please use alcohol to clean the windshield and suction cup of the bracket. Wait for dry and press suction-cup on the windshield
3. Hold the base firmly on the windshield and press down the clamp to mount the car holder to the windshield. Make sure the base is securely locked in place.

2.2.2 Adjust the camcorder position

1. Loosen the small screw to swivel the device vertically or horizontally.
2. Then tighten the small screw to make sure the camcorder is securely locked in place.

2.3 Connecting to Power

Use **only** the supplied car charger to power up the camcorder and charge the built-in battery.

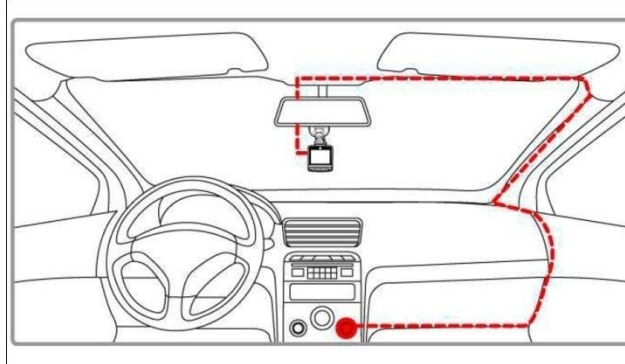

1. Connect one end of the car charger to the USB connector of the camcorder.

USB port input: DC 5V / 1A.

2. Plug the other end of the car charger to the cigarette lighter socket of your vehicle. Once the vehicle engine is started, the camcorder will automatically turn on.

Car charger input: DC 12 / 24V.

Note:

1. Use the product with the supplied charger only, please do not use other power chargers to avoid camera burn or cause the battery explosion.

2. When use this camcorder for the first time, please charging to battery full.

3. Please be noted that if the ambient temperature reaches 45°C or above, the car charger may supply power to camcorder, but it will not charge the Lithium-ion battery.

2.4 Camcorder on/off

2.4.1 Auto On/Off: the device will automatically turn on when the car engine starts up, and automatically start recording when the camcorder turns on. Once the engine stopped, the device will automatically save the recording and turn off (Please set <Delay Power Off> to 15s, see Page 9).

2.4.2 Manual On/Off: long press the power button to turn on/off the camcorder.



2.5 Set date and time prior to use

2.5.1 The device will automatically start recording when turns on, please press the **OK** button to stop recording and enter Standby Mode.

2.5.2 Press the **Menu** button once to enter Recording setting, press **▼** button to select <Time Zone>, press **OK** to enter time zone setting, press **▲/▼** to set the time zone to <+0> for UK, Press **OK** button to confirm.

2.5.3 From Standby Mode, press **Menu** button twice to enter system setting, press **▼** button to select <Time Setup>, press **OK** button to enter time setting. Press the **▲** or **▼** button to adjust the value of date/time, press the **OK** button to enter another field. Press **OK** button to confirm the value and press **Menu** button to exit.

3 To Use the Device as a Video Recorder

In Recording Mode, this  icon will show up on the top left corner of the screen, when camcorder is recording, the red dot  is blinking on top left corner and the Recording indicator on left is blinking blue.

3.1 Record videos while driving

When the car engine starts up, the device will automatically turn on and start recording. When the engine stops, the device will automatically stop recording. Or you can manually stop recording by pressing **OK** button.

Note: the cigarette lighter sockets of some vehicles provide continuous power supply even when the engine stops. If this is the case, please turn off the device manually or unplug the car charger from a car cigarette lighter socket.

3.2 Record all other types of videos

Press the **OK** button to start recording; press the **OK** button again to stop recording.

Note: (1) the device will save recordings every 1,3,5 minute, please refer to the loop setting.

(2) The recordings will be saved to SD card inserted. If the SD card is full, the oldest file will be automatically overwritten.

(3) The collision recording or emergency recordings cannot be overwritten and requires manual deletion.

3.3 Emergency Recording

Note: If G-sensor is enabled and a collision is detected, the device will automatically lock the current recording and this recording will not be overwritten.

3.4 Menu setting operations

- (1) Press **OK** button to stop recording.
- (2) Press the **Menu** button to bring up the menu.
- (3) Press **▲** or **▼** button to select menu items.
- (4) Select the settings you want to modify, press **OK** button to enter the setting.
- (5) After the setting is modified, press **Menu** button to return to standby mode.

Record mode settings	
Menu Options	Available options
Video Resolution	[2560x1080@30P 21:9/2304x1296@30P 16:9/1920x1080@30P 16:9/ HDR 1920x1080@30P 16:9/1280x720@30P 16:9] 2304x1296 is best for day; HDR 1920x1080 is best for night.
Image Quality	[Super Fine, Fine, Normal]
Meter Mode Setting	[Center, Average, Spot] Center: center-weighted average metering; Average: average metering; Spot: spot metering.
Light Freq	[Auto / 50Hz / 60Hz]. Choose the correct frequency for the power line to avoid flickering. For UK, please choose 50Hz.

Date Stamp Setting	[On/Off] When it is ON, model number/speed/plate number/date/time (preset) will be shown at the right bottom corner of the screen and will appear on the recording files.
ADAS Detect	[On / Off] ADAS stands for Advanced Driver Assistance Systems, which including: A: <i>Lane-Departure-Warning-System</i> : If lane-changing occurs, warning picture will appear to warn the driver; B: <i>Low-Light-Warning-System</i> : t will remind you to turn on the headlight if you drive in low-light condition C: <i>Driver-Fatigue-Warning-System</i> : device will send a warning picture and warning tone to the driver when continuous driving (more than 4 hours) is detected, followed by the same every two hours.
Loop Setting	[1min/3min/5min] The device will generate a file every 1min/3min/5min. Once the capacity is full, the oldest file will be overwritten. A 32GB SD card can record continuously for around 3 hours at the best resolution 1296P before the capacity is full.
Time Zone	[-12~+12] Set the time zone for different country. "+0" for London.
AE Bias	[-2.0EV~+2.0EV] Adjust the EV value to make the footage or snapshot brighter or dimmer.
Speed Warning Setting	[Off/80KMH/120KMH] If the driving speed exceed the preset value, the camcorder will give out alarm to warn the deriver. Note: this feature is only available with GPS dongle inserted.
LED Setting	[On/Off] If set to Off, the LED light on the buttons will turn off.
G-Sensor Setting	[Off/Low/Medium/High] This refers to the sensitivity. Under G-Sensor mode, when an impact is detected the footage will be saved anyways.
Motion Detection	[On/Off] Under Motion Detection mode, the camcorder records automatically when it senses movement in front of it. Please disable it when driving.
System settings	
Menu Options	Available options
Language Setting	[English/Russian/Simplified Chinese/Traditional Chinese]
Record Mode Setting	[Auto Record/Manual Record] When set to Auto Record, the camcorder will automatically start recording when the car starts up; when set to Manual Record, you will need to press the power button to turn on the camcorder.

System Mode	[NTSC/PAL] Please set to PAL when you are in UK.
Driver ID Setting	Set up the plate number for the car
Time Setup	Set up the date and time display for the recording
Format	To format your SD card
Default Setting	To turn the camcorder to factory default settings
Backlight Off Setting	[Off/1 min/3 min/5 min] Device will automatically turn off the display after certain amount of time you set. It is also called screen saver. The recording will continue though screen goes black.
Delay Power Off	[Off/15 sec/30 sec/1 min] Device will automatically power off (when you unplug the power supply) after certain amount of time. If set to Off, the device will turn off when battery drains up.
Beep Sound Setting	[On/Off] Turn on/off the sound when the camcorder starts up/turns off and when you press the button.
Version Info	Shows the firmware version of the device.

4 To Use the Camera for Taking Pictures ONLY

4.1 Enter Picture Mode

If you want to use the camera to take pictures only (not record), then you can change it to the Picture Mode. To enter the Picture Mode, press **Mode** button (left button) to change. In Picture Mode, you can see a camera icon like this  located to the top left corner of the screen.

Note: If camera is in Recording Mode and it is recording (the red dot  blinking on top left corner and the recording indicator is blinking blue), press **OK** button to stop the recording first, and then press **Mode** button to go to Picture Mode.

4.2 Take Pictures

Under Picture Mode, you can press **OK** button to take pictures.

4.3 Enter Menu for Picture Mode

To access the menus for Picture Mode, press the **Menu** button once when you are in Picture Mode.

Picture settings	
Menu Options	Available options
Picture Resolution	[4M (2688x1512 16:9) or 9M (4000x2250 16:9) or 13M (4800x2700 16:9)]
Image Quality	[Super Fine, Fine, Normal]
Date Stamp Setting	[On/Off]. Whether the snapshot will come with date/time display or not.

5 Accessing, Playback and Delete Files

5.1 Enter Preview Mode

To enter Preview Mode, in recording mode, please press **OK** button to stop recording first, then press **Mode** button for twice.

5.2 Enter Menu for Preview Mode

To access the menus for Picture Mode, press the **Menu** button once when you are in Preview Mode.

Picture settings	
Menu Options	Available options
Play Mode Setting	[Play One, Play All, Repeat One, Repeat All] Illustration please refer to 5.2.4
Delete File	Delete the selected file

5.3 Preview Recordings/Pictures

5.2.1 When you are in Preview Mode, please **Up** button to select Normal File Category (Recordings saved in file named NORMAL) or Emergency File Category (Recordings saved in file named EVENT).

5.2.2 Press **OK** button to choose the category you want to view. Then the last footage/picture will be enlarged which means it is selected and the footage/picture name will be displayed. (suffix .MOV is for footage and .JPG for pictures).

5.2.3 Press **Up** button to select the footage/picture you want to preview, press **OK** button then the footage/picture will be on full screen.

5.2.4 Press **OK** button to start to playback the footage.

If you set the Play Mode Setting to <Play one>, the device will stop playback when a recording is ended; if set to <Play All>, the device will continue to playback next recording saved when this one ended; if set to <Repeat one>, the device will repeat playback the recording you've chosen; if set to <Repeat All>, the device will repeat playback all recordings saved.

5.2.5 You can press **OK** button to stop playback, then press **Mode** button to go back to previous page.

Note: when you are selecting category or files, please press **Up** button only, DO NOT press **Down** button, otherwise you will go back to recording mode.

5.4 How to delete Files?

On camcorder, only files under Normal File Category can be deleted. Files under Emergence File Category should be deleted on computer.

If you want to delete files, press OK to select it, press the **Menu** button to bring up the menu, press Down button to select <Delete File>, press **OK** button to enter the setting and the options are shown below:

Delete this file; Delete all files

1) If you choose <Delete this file> and press **OK** to confirm. You should see this:

Delete this file? – ✓ X

You can choose ✓ and press **OK** to confirm the action.

2) If you choose <Delete all files> and press **OK** to confirm. You should see this:

Delete all files? – ✓ X

You can choose ✓ and press **OK** to confirm the action.

Note: If a file is locked (protected), you will not be able to delete it on the camcorder, but you can delete it on your computer.

5.5 How to Access the Files on Computer?

Please connect the Camcorder to a computer via a USB cable, the USB cable should be connected to the USB port on the right side of the camcorder, not DC IN port. The device will show up as a **Removable Disk** on your computer. It normally contains folders as below:

EVENT: This file contains emergency recordings which will not be overwritten in the loop recording. The device can save up to 50 emergency recordings. This files requires manual deletion on computer.

HD Player: This file contains default player Eyelog and DataKam, which are compatible with Windows system ONLY.

NORMAL: This file contains normal recordings saved and pictures you have taken. These recordings can be overwritten in the loop recording. You can delete these recordings/pictures either on camcorder on or on computer.

5.6 Playback Files on Computer

Please install these two players on your Windows computer. Add the files to player by clicking the Green “+” icon.



If your camcorder has a GPS dongle, you can see the GPS information (Route/speed etc.) on the player as well as recorded footage while playback. If your camcorder does not have a GPS, dongle, you will be able to read the G-senor data and recorded footage with these two players. You can also playback the footage by windows media player or Quick Time player, but the image quality could be impacted in some cases.

6 Specifications

Items	Technical specification
Image Sensor	5MP
Maximum Display Resolution	2304x1296 30P
Storage Media	Support Micro SDHC, up to 32GB class 10 or above
LCD Display	3.0" LCD color TFT
Lens	170-Degree Fixed Focus lens
Focus Range	0.5m~Infinity
Ae Bias	-2.0~2.0EV
Video (Format: MOV)	Resolution: [2560x1080@30P 21:9, 2304x1296@30P 16:9, 1920x1080@30P 16:9, HDR 1920x1080@30P 16:9, 1280x720@30P 16:9]
Still Image(Photograph) (Format: JPEG)	Resolution: [4M (2688x1512 16:9), 9M (4000x2250 16:9), 13M (4800x2700 16:9)]
ADAS Detect	Lane departure warning system, Low light warning system, Driver fatigue warning system
G-Sensor	3-Axis G-Force sensor
Loop Setting	1min/3min/5min
GPS	Support
Microphone	Support
Speaker	Support
Time/Date Stamp	Support
Connection	Mini USB
Battery	Built-in Li-polymer rechargeable
Operating Temperature	0 ~ 50° C
Operating Humidity	20 ~ 70% RH
Storage Temperature	-20 ~ 80° C
Dimensions	110 x 47 x 31.5 mm
Weight	Approx. 118g (without memory card)
Operating System	Windows

7 Frequently Asked Questions (FAQs)

Why won't the camera auto-start?

- * Make sure if the power cable goes DC IN port on the top of the camcorder (not the USB port on the right side of the device)
- * Check if the Record Mode Setting is set to <Auto>.
- * It could be the car charger design. Since there are so many brands of cars on market, so do the car socket design. Our car charger may not be compatible with all car models. If our car charger is not compatible with your car, you can contact us for further resolution on this.

What is the maximum allowed memory capacity for the camera?

While up to 64GB may be functional, we guarantee only up to 32GB micro SD Card "Class 10" rating as the maximum allowed capacity for the moment.

How do I know the camera is recording?

You'll notice three changes when the camera is recording.

- 1) The second indicator on the left side of the camcorder will blinking blue.
- 2) The round dot icon on the top left of the display will flash red.
- 3) There is a counter on the top right of the display, and the numbers will be increasing identifying how long the file has been recording.

Why my camera freezes a lot, and sometimes even not responding when the buttons are pressed?

If the camera freezes, you can press the Reset button. In most cases, the freezes are related to the card (compatibility etc.). You can try another SD card.

If the SD card is full with emergence files, the camcorder will freeze and will not start recording, in some cased the buttons will refuse to response when pressing. If this is the case, please format the SD card on your computer and then format it again on your camcorder.

You can contact us if the issue cannot be fixed at your end, we will seek possible firmware update for you. If you received a faulty unit we can replace it for you.

Why only 10s footage is saved?

Please check if you have enable the motion detection. The motion detection function will conflict with loop recording and resulting few seconds videos.

Why isn't the video/picture clear?

- * Go to Resolution Setting and make sure you choose the highest resolution.
- * Make sure the lens film is removed prior to use
- * Make sure there are no fingerprints, dirt, or water on the lens, and clear the camera lens using a piece of wet cloth on regular basis.
- * Please use the players in the **HD Player** file for the playback. As per experience, sometimes, the footage will be pixelated on Windows Media Player, but actually the recording is clear, it is just the player issue.

I cannot get to the settings menu?

Make sure the camera is not recording (you can press **OK** button to stop recording) and press the **Menu** button (top right one) to bring up the Record/Picture/Preview Mode Menu. Press **Menu** button again to bring up the System Menu.

What is "Loop Recording"?

All of our dash cams are currently utilizing the loop recording system. The options are 1/3/5 minutes. For example, if it is set to 5min, the camcorder will generate a file every 5 minutes. Once the SD card capacity is full, the oldest file will be overwritten by the latest one.

Is there a "Emergency" button to start recording and save on demand on the camcorder?

Yes. Just press the **Menu** button once (when the camera is recording) to achieve this function. There will be an exclamation mark  next to the counter. Press OK button to stop the emergency recording. Emergency recordings will not be overwritten.

What is a "G-Sensor" feature on a dash camera?

A "G Sensor" is a feature / setting that allows a specific video file that is actively being produced / recorded to be "locked" and protected from becoming deleted as the camera continues to record video while in " loop". Cameras have low, medium and high settings for G-sensor. If the setting is set too high, then the camera may "lock" files every time you come to a quick stop or run over a pothole. The G-Sensor setting must be used cautiously and experimented with for each driver and vehicle. It is suggested that a new camcorder owner drive with G-sensor set to off or in the low setting in order to get a "feel" for how it functions in a particular vehicle and driving style.

How is the motion detection function for?

Under motion detection, the camcorder will capture moving objects in front of your car. You can use it in parking lot. The battery of the camcorder will not last long, so it is recommended to use a power bank to power the device.

Why there is strips in the image?

Please adjust the Frequency (50Hz/60Hz) of the camcorder.

In case of device shutdown in abnormal condition:

Please press the "RESET" button on the button of the device and restart the device.

How do I know if the GPS is working?

- * The bottom indicator at the left side of the camcorder will be constant green;
- * The GPS icon on the left side of the screen will be green, (it will take a few time for the GPS function to be connected);
- * If the Date/Time stamp is enabled, there will be speed info showing on the right bottom corner of the screen.